

## DESCASCADORES E POLIDORES

Para pergaminho

## HULLERS AND POLISHERS

For parchment

## TRILLADORAS Y PULIDORAS

Para pergaminho



DEPOS



DEPOL



DBD

DEPOS-2 / DEPOS-4 / DEPOS-6

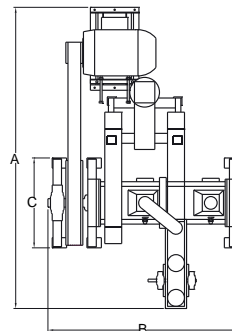
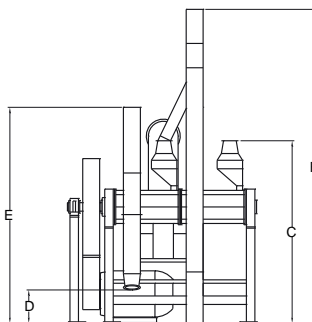
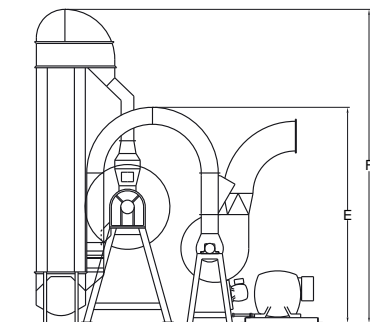

DEPOL

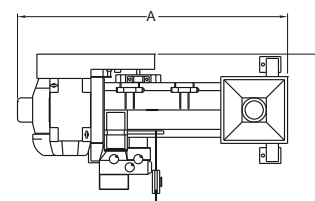
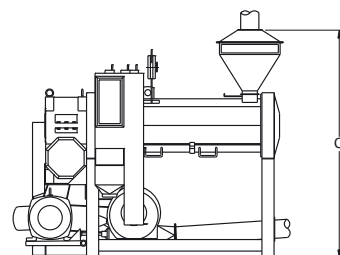
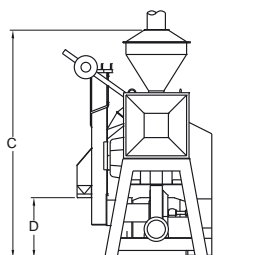

DBD

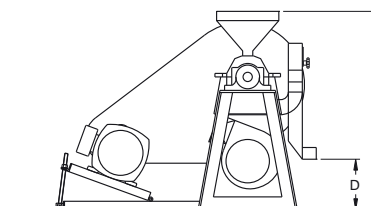
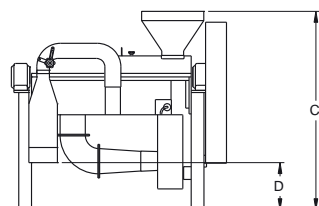
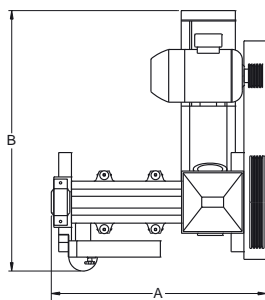

| TIPO<br>TYPE<br>TIPO | DIMENSÕES - DIMENSIONS - DIMENSIONES |      |      |      |      |      |
|----------------------|--------------------------------------|------|------|------|------|------|
|                      | m                                    |      |      |      |      |      |
|                      | A                                    | B    | C    | D    | E    | F    |
| DBD-05               | 0,95                                 | 0,85 | 1,15 | 0,25 | -    | -    |
| DBD-15               | 1,40                                 | 1,65 | 1,15 | 0,30 | -    | -    |
| DEPOL-2              | 2,25                                 | 1,25 | 1,90 | 0,50 | -    | -    |
| DEPOS-2              | 2,30                                 | 3,60 | 2,20 | 0,40 | 2,60 | 3,70 |
| DEPOS-4              | 2,30                                 | 3,60 | 2,20 | 0,40 | 2,60 | 3,70 |
| DEPOS-6              | 2,30                                 | 3,60 | 2,20 | 0,40 | 2,60 | 3,70 |

| TIPO<br>TYPE<br>TIPO | MOTOR ELÉTRICO<br>ELECTRIC MOTOR<br>MOTOR ELÉCTRICO | CAPACIDADE<br>CAPACITY<br>CAPACIDAD | PESO LÍQUIDO<br>NET WEIGHT<br>PESO NETO | VOLUME<br>VOLUME<br>CUBAJE |
|----------------------|---|-------------------------------------|---|----------------------------|
|                      | HP  | kg/h                                | Kg                                      | m <sup>3</sup>             |
|                      | DBD-05  | 1 / 12,5                            | 300 / 400                               | 330                        |
| DBD-15               | 25  | 900 / 1.200                         | 750                                     | 2,18                       |
| DEPOL-2              | 2 / 50  | 1.800 / 2.400                       | 2.150                                   | 4,04                       |
| DEPOS-2              | 1 / 15 / 50*  | 2.000                               | 3.700                                   | 20,24                      |
| DEPOS-4              | 1 / 15 / 75*  | 4.000                               | 3.800                                   | 20,24                      |
| DEPOS-6              | 1 / 15 / 100*                                       | 6.000                               | 6.000                                   | 20,24                      |

\* Motor de 6 polos      \* Six-pole motor      \* Motor de 6 polos  
Reservamos o direito de alterar as características técnicas sem aviso prévio. We reserve the right to change the technical features without previous notice. Reservamos el derecho de alterar las características técnicas sin aviso previo.